

IDA-5

Infusion Device Analyzer

Users Manual

Warranty and Product Support

Fluke Biomedical warrants this instrument against defects in materials and workmanship for one year from the date of original purchase OR two years if at the end of your first year you send the instrument to a Fluke Biomedical service center for calibration. You will be charged our customary fee for such calibration. During the warranty period, we will repair or at our option replace, at no charge, a product that proves to be defective, provided you return the product, shipping prepaid, to Fluke Biomedical. This warranty covers the original purchaser only and is not transferable. The warranty does not apply if the product has been damaged by accident or misuse or has been serviced or modified by anyone other than an authorized Fluke Biomedical service facility. NO OTHER WARRANTIES, SUCH AS FITNESS FOR A PARTICULAR PURPOSE, ARE EXPRESSED OR IMPLIED. FLUKE SHALL NOT BE LIABLE FOR ANY SPECIAL, INDIRECT, INCIDENTAL OR CONSEQUENTIAL DAMAGES OR LOSSES, INCLUDING LOSS OF DATA, ARISING FROM ANY CAUSE OR THEORY.

This warranty covers only serialized products and their accessory items that bear a distinct serial number tag. Recalibration of instruments is not covered under the warranty.

This warranty gives you specific legal rights and you may also have other rights that vary in different jurisdictions. Since some jurisdictions do not allow the exclusion or limitation of an implied warranty or of incidental or consequential damages, this limitation of liability may not apply to you. If any provision of this warranty is held invalid or unenforceable by a court or other decision-maker of competent jurisdiction, such holding will not affect the validity or enforceability of any other provision.

7/07

Notices

All Rights Reserved

© Copyright 2014, Fluke Biomedical. No part of this publication may be reproduced, transmitted, transcribed, stored in a retrieval system, or translated into any language without the written permission of Fluke Biomedical.

Copyright Release

Fluke Biomedical agrees to a limited copyright release that allows you to reproduce manuals and other printed materials for use in service training programs and other technical publications. If you would like other reproductions or distributions, submit a written request to Fluke Biomedical.

Unpacking and Inspection

Follow standard receiving practices upon receipt of the instrument. Check the shipping carton for damage. If damage is found, stop unpacking the instrument. Notify the carrier and ask for an agent to be present while the instrument is unpacked. There are no special unpacking instructions, but be careful not to damage the instrument when unpacking it. Inspect the instrument for physical damage such as bent or broken parts, dents, or scratches.

Technical Support

For application support or answers to technical questions, either email techservices@flukebiomedical.com or call 1-800-850-4608 or 1-440-248-9300. In Europe, email techsupport.emea@flukebiomedical.com or call +31-40-2965314.

Claims

Our routine method of shipment is via common carrier, FOB origin. Upon delivery, if physical damage is found, retain all packing materials in their original condition and contact the carrier immediately to file a claim. If the instrument is delivered in good physical condition but does not operate within specifications, or if there are any other problems not caused by shipping damage, please contact Fluke Biomedical or your local sales representative.

Returns and Repairs

Return Procedure

All items being returned (including all warranty-claim shipments) must be sent freight-prepaid to our factory location. When you return an instrument to Fluke Biomedical, we recommend using United Parcel Service, Federal Express, or Air Parcel Post. We also recommend that you insure your shipment for its actual replacement cost. Fluke Biomedical will not be responsible for lost shipments or instruments that are received in damaged condition due to improper packaging or handling.

Use the original carton and packaging material for shipment. If they are not available, we recommend the following guide for repackaging:

- Use a double-walled carton of sufficient strength for the weight being shipped.
- Use heavy paper or cardboard to protect all instrument surfaces. Use nonabrasive material around all projecting parts.
- Use at least four inches of tightly packed, industry-approved, shock-absorbent material around the instrument.

Returns for partial refund/credit:

Every product returned for refund/credit must be accompanied by a Return Material Authorization (RMA) number, obtained from our Order Entry Group at 1-440-498-2560.

Repair and calibration:

To find the nearest service center, go to www.flukebiomedical.com/service or

In the U.S.A.:

Cleveland Calibration Lab
Tel: 1-800-850-4608 x2564
Email: globalcal@flukebiomedical.com

Everett Calibration Lab
Tel: 1-888-99 FLUKE (1-888-993-5853)
Email: service.status@fluke.com

In Europe, Middle East, and Africa:

Eindhoven Calibration Lab
Tel: +31-40-2675300
Email: ServiceDesk@fluke.com

In Asia:

Everett Calibration Lab
Tel: +425-446-6945
Email: service.international@fluke.com

To ensure the accuracy of the Product is maintained at a high level, Fluke Biomedical recommends the product be calibrated at least once every 12 months. Calibration must be done by qualified personnel. Contact your local Fluke Biomedical representative for calibration.

Certification

This instrument was thoroughly tested and inspected. It was found to meet Fluke Biomedical's manufacturing specifications when it was shipped from the factory. Calibration measurements are traceable to the National Institute of Standards and Technology (NIST). Devices for which there are no NIST calibration standards are measured against in-house performance standards using accepted test procedures.

WARNING

Unauthorized user modifications or application beyond the published specifications may result in electrical shock hazards or improper operation. Fluke Biomedical will not be responsible for any injuries sustained due to unauthorized equipment modifications.

Restrictions and Liabilities

Information in this document is subject to change and does not represent a commitment by Fluke Biomedical. Changes made to the information in this document will be incorporated in new editions of the publication. No responsibility is assumed by Fluke Biomedical for the use or reliability of software or equipment that is not supplied by Fluke Biomedical, or by its affiliated dealers.

Manufacturing Location

The IDA-5 Infusion Device Analyzer is manufactured at Fluke Biomedical, 6920 Seaway Blvd., Everett, WA, U.S.A.

Table of Contents

Title	Page
Introduction.....	1
Intended Use	1
Unpack the Product.....	1
Safety Information	2
Symbols.....	4
Instrument Familiarization	5
Product Connections	7
Connect Infusion Devices.....	7
Connect Drains to the Product	8
Connect Accessories.....	8
Keyboard	9
Bar Code Reader.....	9
Printer	9
Product Operation	9
Preferences	10
How to Test Infusion Devices.....	11
Flow Tests	14
Occlusion Tests.....	18
How to Test PCA Pumps.....	21
Dual Flow Pump Test	23
Templates.....	23
Define a Template	24
Template Operation.....	25
Utilities	26
Recall Tests.....	26
Set Clock	27
User Preferences.....	27
Printer Setup/Test.....	27
Cancel Print.....	27
Instructions	27
Report Header	27
Default Test Preferences.....	27
Calibration	28
Edit Templates.....	28
Troubleshooting.....	29
Product Maintenance	30

Clean the Product.....	30
Outside	30
Inside	30
Replaceable Parts	31
Test Fluid.....	32
Storage	32
Shipping.....	32
General Specifications	33
Performance Specifications.....	33

List of Tables

Table	Title	Page
1.	Symbols.....	4
2.	Front-Panel Controls and Connections	5
3.	Rear-Panel Controls and Connections.....	6
4.	Channel Setup Screen Controls.....	11
5.	Device Information Fields.....	12
6.	Device Information Controls	13
7.	Device Detail Information Fields.....	13
8.	Flow Screen Menu Controls	15
9.	Channel Flow Measurement Parameters.....	15
10.	Flow Graph Screen Controls	16
11.	Flow Screen in End Mode	17
12.	Occlusion Screen in Start Mode.....	18
13.	Occlusion Screen in Active Mode.....	19
14.	Occlusion Screen in End Mode	20
15.	PCA/Dual Information Screen	21
16.	PCA Screen in Active Mode	22
17.	Template Detail Screen	24
18.	Recall Tests Screen	26
19.	Bubble Errors	29
20.	Air Lock Errors.....	29
21.	Replaceable Parts	31

List of Figures

Figure	Title	Page
1.	Infusion Device Connections to the Product	7
2.	Drain Connections to the Product	8
3.	Status All Channels	9
4.	Utilities Screen	10
5.	Channel Flow Screen	14
6.	Channel Flow Graph	16
7.	Occlusion Graph Screen	19
8.	PCA Screen - Prime Mode	22
9.	PCA Graph Screen.....	23
10.	Utilities Menu Screen	26
11.	Default Test Preferences Screen	27

Introduction

The Fluke Biomedical IDA-5 Infusion Device Analyzer (the Product) is a precision instrument that examines the performance of medical infusion devices. The Product measures the flow rate and volume supplied, and the pressure generated in occlusion or blockages of the fluid line. A maximum of 4 infusion devices can be independently examined with the four-channel version of the Product.

Intended Use

The Product is to be used by infusion device manufacturers, hospital biomedical engineering departments, and third-party service organizations. Use the Product to verify accurate performance of infusion devices through measurement of flow, volume, and pressure. The performance of a wide range of infusion devices can be analyzed including syringe, drop counting, peristaltic, and volumetric types. Non-steady flow rate pumps can also be analyzed. The Product uses distilled or deionized water with an optional wetting agent only.

Unpack the Product

Carefully unpack all items from the box and check that these items are included:

- The Product
- Power Cord
- Accessory Set (syringe, stopcocks, drain tubing, and Micro 90®)
- CD (contains Users Manual and HydroGraph software)
- USB Cable

Safety Information

A **Warning** identifies hazardous conditions and actions that could cause bodily harm or death. A **Caution** identifies conditions and actions that could harm the Product, the equipment under test, or cause permanent loss of data.

Warning

To prevent possible electrical shock, fire, or personal injury:

- Read all safety information before you use the Product.
- Carefully read all instructions.
- Use the product only as specified, or the protection supplied by the product can be compromised.
- Do not use the Product if it operates incorrectly.
- Do not use the Product if it is damaged.
- Disable the Product if it is damaged.
- Use this Product indoors only.
- Connect an approved three-conductor mains power cord to a grounded power outlet.
- Never use a two-prong plug adapter to connect primary power to the Product.
- Use only the mains power cord and connector approved for the voltage and plug configuration in your country and rated for the Product.
- Turn the Product off and remove the mains power cord before cleaning the outer surface of the Product.
- Make sure the ground conductor in the mains power cord is connected to a protective earth ground. Disruption of the protective earth could put voltage on the chassis that could cause death.
- Replace the mains power cord if the insulation is damaged or if the insulation shows signs of wear.
- Do not open the Product unless you are qualified.
- Do not use the Product around explosive gas, vapor, or in damp or wet environments.
- Do not use the Product on infusion devices that are attached to patients.
- Do not reuse test tubing or syringes for patient infusion.

- **Avoid possible contamination of reusable components due to backflow conditions. Some older style infusion devices may have reusable components that could come in direct contact with the fluids being pumped. When testing these types of devices take care to avoid possible contamination of reusable components.**
- **Do not use delivery set or components that have been used for testing for patient infusion.**
- **Do not connect the Product to a patient or equipment connected to a patient. The Product is intended for equipment evaluation only and should never be used in diagnostics, treatment or in any other capacity where the Product would come in contact with a patient.**
- **The Product must be properly earthed. Only use a supply socket that has a protective earth contact. If there is any doubt as to the effectiveness of the supply socket earth, do not connect the Product. Do not use a two-conductor adapter or extension cord. This will break the protective ground connection.**
- **Many components on the printed circuit board are static sensitive. ESD precautions should be observed when handling the printed circuit board assembly.**
- **To avoid shock hazard and for proper Product operation, connect the factory supplied three-conductor line power cord to a properly grounded power outlet. Do not use a two-conductor adapter or extension cord; this will break the protective ground connection.**
- **The Product is intended for use by trained service technicians to perform periodic inspections on a wide range of medical equipment. The testing procedures are menu-driven and simple to operate.**
- **The Product is intended for use with single-phase, grounded power. It is not intended for dual, split-phase or three-phase power configurations. But it can be used with any power system that supplies the correct voltages for single-phase and is grounded.**
- **This Product is intended to be used in the laboratory environment, outside of the patient care area, and is not intended for use on patients, or to test devices while connected to patients. This Product is not intended to be used to calibrate medical equipment and not intended for over the counter use.**

⚠ Caution





To prevent possible damage to the product or to equipment under test:

- Only qualified service personnel should service the Product.
- Only qualified technical personnel should perform troubleshooting and service procedures on internal components.
- Only use degassed de-ionized water with the Product. Wetting agent may be added.
- Do not use high-viscosity fluids. Oils (solvents, or strong chemicals) may also damage or contaminate the Product.
- Do not use "Bleach" sterilizing agents or alcohols.
- Do not rapidly switch the Product On or Off, nor remove the line cord while energized.
- Remove internal water before shipping or storing. Do not use compressed air to clean out the Product.
- Do not expose the Product to temperature extremes. For proper operation, ambient temperatures should be from 15 °C to 30 °C (59 °F to 86 °F). Performance may be adversely affected if temperatures fluctuate above or below this range. For Storage Temperature limits, see the Specifications section.
- Do not use the Product in close proximity to sources of strong electromagnetic radiation (e.g., unshielded intentional RF sources). These sources may interfere with proper operation.

Symbols

Table 1 is a list of symbols used on the Product and in this document.

Table 1. Symbols

Symbol	Description	Symbol	Description
	Risk of Danger. Important information. See Manual.		Hazardous voltage. Risk of electric shock.
	Conforms to European Union directives.	CAT II	Measurement category II is applicable to test and measuring circuits connected directly to utilization points of low voltage mains installation.
	This product complies with the WEEE Directive (2002/96/EC) marking requirements. The affixed label indicates that you must not discard this electrical/electronic product in domestic household waste. Product Category: With reference to the equipment types in the WEEE Directive Annex I, this product is classed as category 9 "Monitoring and Control Instrumentation" product. Do not dispose of this product as unsorted municipal waste. Go to Fluke's website for recycling information.		

Instrument Familiarization

Tables 2 and 3 tell you about the controls and connections on the front and rear panels of the Product.

Table 2. Front-Panel Controls and Connections

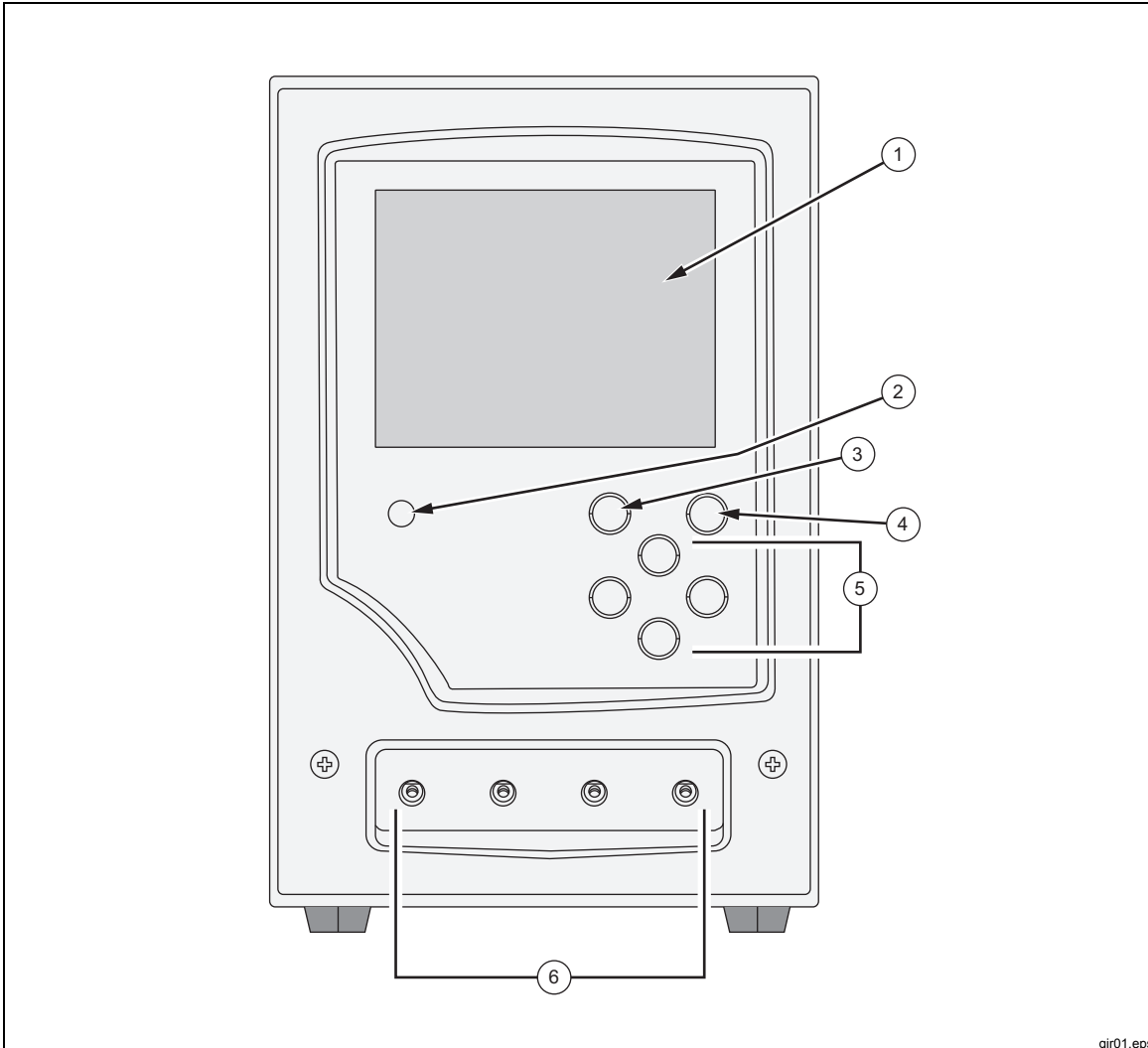

gir01.eps

Item	Description
①	Display (LCD)
②	Power on indicator
③	ESC (escape) button – Moves back one step or does the operation given on the display.
④	ENTER button – Operates the highlighted function or moves to the subsequent data-entry field.
⑤	Arrow buttons – Moves the highlight on menus in the direction of the arrow or operates the function shown on the display.
⑥	Flow inlet ports – One port for each measurement channel.

Table 3. Rear-Panel Controls and Connections

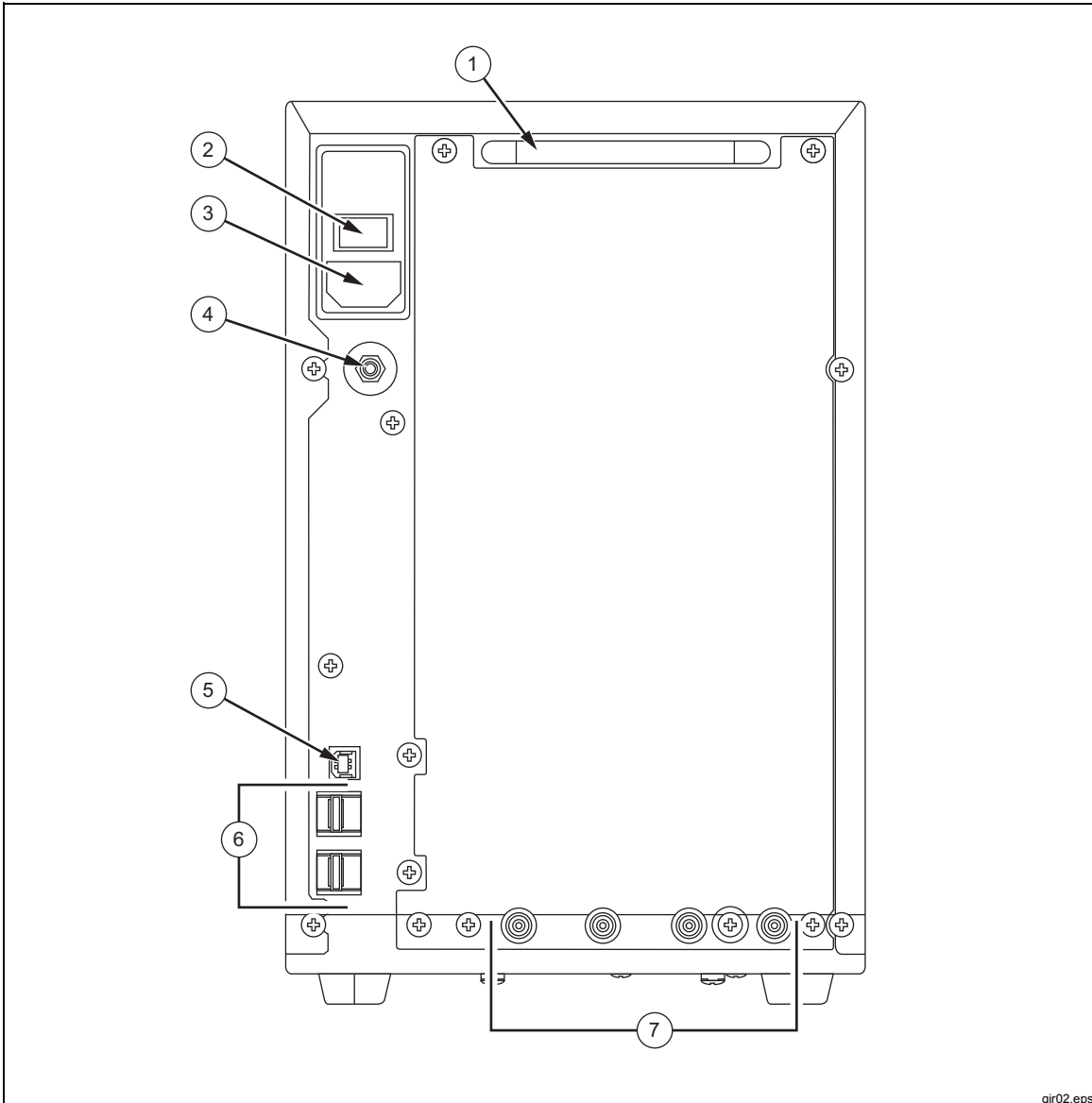

gir02.eps

Item	Description
①	Handle
②	Power switch
③	Power inlet
④	Equipotential post
⑤	USB "B" connector – Computer connection.
⑥	USB "A" connectors – Connect a maximum of four accessories such as: Keyboard Printer Bar-Code reader
⑦	Fluid outlets – One per measurement channel. Channel 1 at right and channel 4 at left.

Product Connections

The Product connects to infusion devices through the front-panel inlet ports. Fluid drain hoses and accessories connections are made through the rear-panel connections.

Connect Infusion Devices

As shown in Figure 1, it is recommended that all infusion device connections be made to the Product front-panel inlet connectors through 3-way stopcocks.

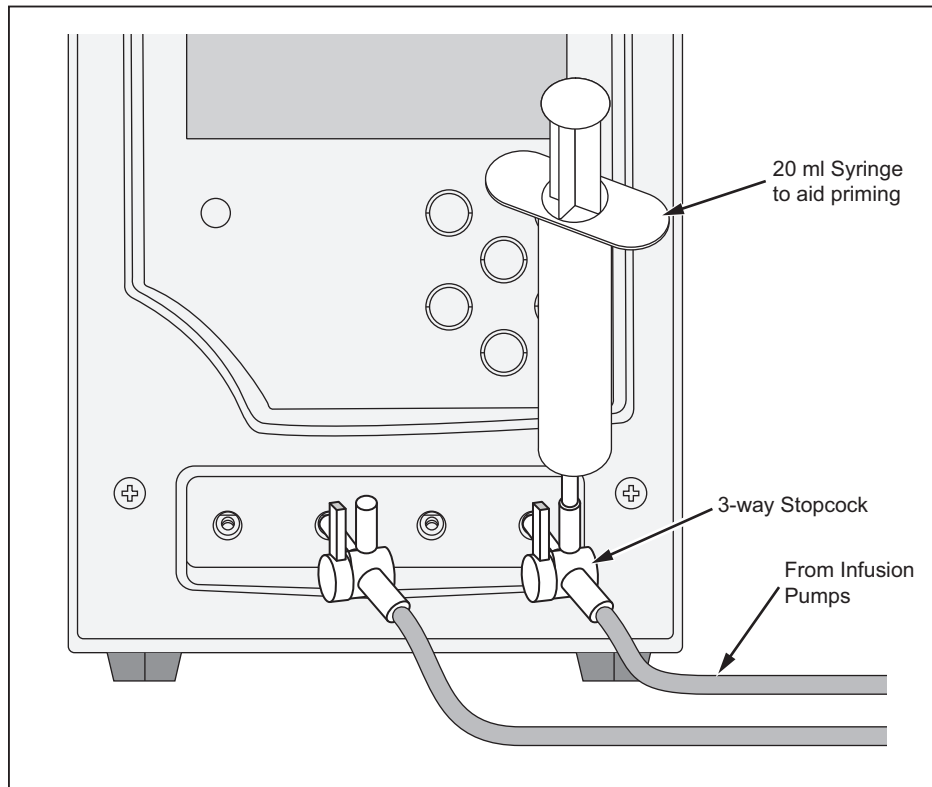

gir03.eps

Figure 1. Infusion Device Connections to the Product

The channel 4 inlet shown in Figure 1, shows a 20 ml syringe attached to one 3-way stopcock inlet. The syringe can be used to help priming. It can be used as shown or can be connected further away from the inlet to help for flow tests. The syringe can be shared among the channels and removed after the channel is primed.

Follow these recommendations when you connect to the inlet tubing circuits:

- Use adequate prime volumes (for example, 10 ml) to push through any bubbles.
- Use the stopcocks at the inlet to prevent fluid backflow out of inlets between tests.
- When you connect to the inlet circuits (for example, when you attach the priming syringes to the stopcocks) make sure no new bubbles are introduced.

⚠ Caution

Do not use delivery set or components that have been used for prior testing for patient infusion.

Note

Before you use the delivery set (tubing, syringe, etc.), make sure it is within the specified use period of the manufacturer. Many sets are made to be used only once.

Connect Drains to the Product

Figure 2 shows tubing connected to the rear-panel outlets of the Product.

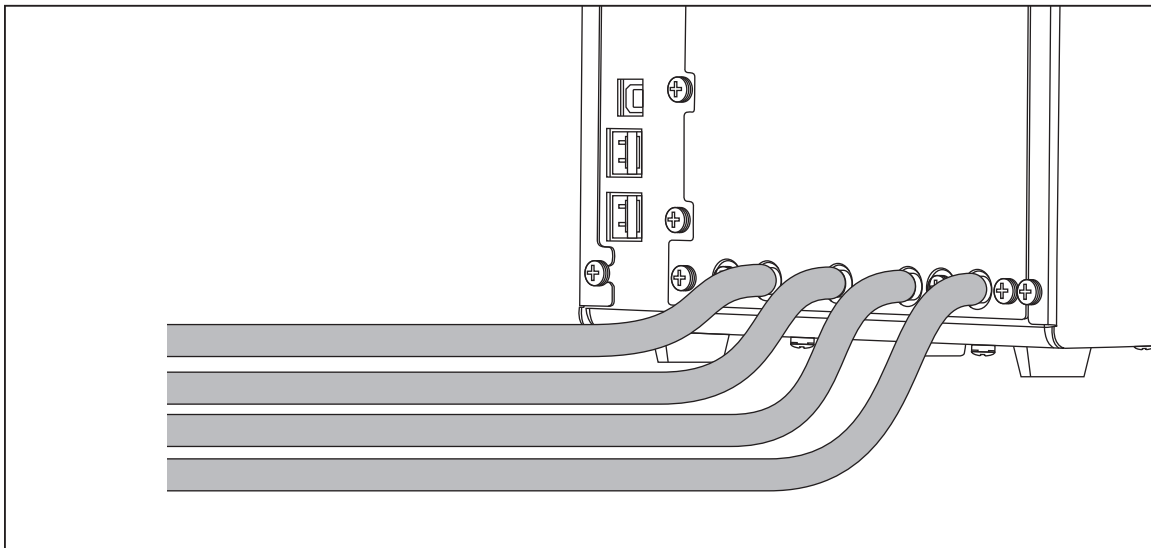

gir04.eps

Figure 2. Drain Connections to the Product

When you connect drain tubing to the Product outlets:

- Connect different drain tubes to each channel.
- Do not connect the drain tubes together.
- The drain tubes should not be allowed to rise more than 10 cm (4 in) at any point above the height of the inlet ports of the Product.
- The discharge end of the drain tubes must not be more than 10 cm (4 in) below the bottom of the Product.

Connect Accessories

Accessories connect to any of the four USB “A” ports on the rear-panel of the Product. Use a USB cable that is less than 3 meters long.

Note

Connect all USB accessories after the Product is turned on. When an accessory is connected to a Product that is ON, some seconds are necessary before the accessory is recognized.

Keyboard

It is recommended that a small footprint USB keyboard be used with the Product. The keyboard is necessary to record data about the infusion device under test.

Note

The keyboard must not have an internal USB hub (for example, no extra USB ports).

Bar Code Reader

A bar code reader can also be used to scan infusion device data into the Product.

Printer

A printer that supports PCL-5 (or higher) printer-command language can be used with the Product to print test results and reports.

Product Operation

Before you turn on the Product, make sure the Product calibration is up-to-date and check for signs of wear.

The Product power switch is on the rear panel.

To turn on the product and display the Status All Channels screen:

1. Push the power switch. If the Status All Channels screen in Figure 3 shows without errors, the Product is ready to use.

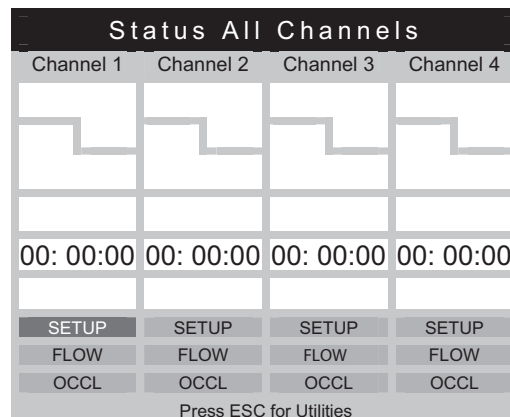

Figure 3. Status All Channels

gir05.eps

2. Control the Product with the four arrow buttons and the **ENTER** and **ESC** (Escape) buttons on the front panel:
 - Four Arrows move the highlight between menu options.
 - **ENTER** operates the highlighted option.
 - **ESC** functionality is described on the bottom of each screen.

Note

The Arrow, Enter, and Esc buttons of a connected keyboard replicate the front-panel buttons.

Preferences

To set your personal preferences, use the Utilities menu. To access this menu, select **ESC** while the Status All Channels screen is shown. The Utilities menu in Figure 4 lets you set user preferences such as LCD brightness, beeper volume, time and date, test preferences, and lets you record text to use as a header of all reports. To read more about these preferences and the other features that are controlled through the Utilities menu, go to the “Utilities” section later in this manual.

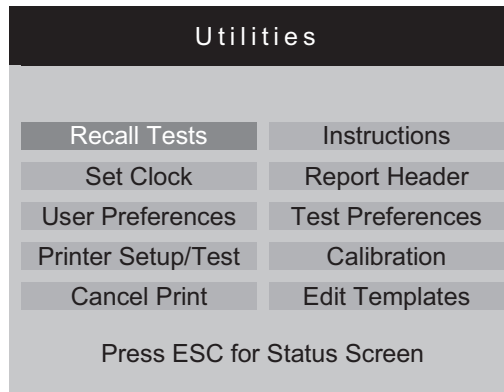

gir22.eps

Figure 4. Utilities Screen

How to Test Infusion Devices

When you test an infusion device, it is recommended that you record the details of the device you are testing and the test parameters. From the Status All Channels screen, select **SETUP** for the relevant channel. These examples use channel 1.

The Channel 1 Setup screen described in Table 4 is shown.

Table 4. Channel Setup Screen Controls

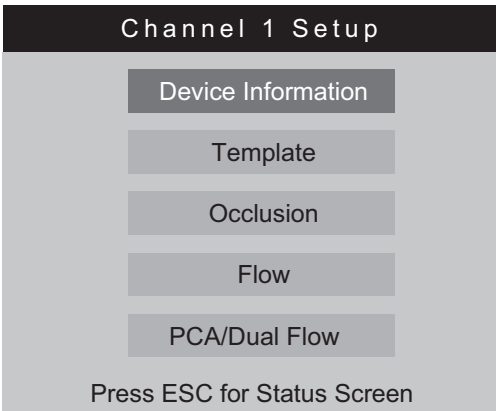

Control	Description
Device Information	Shows a screen that lets you record infusion device data and test details.
Template	Shows a screen that lets you set a template to control a sequence of tests.
Occlusion	Occlusion test without details.
Flow	Flow test without details.
PCA/Dual Flow	PCA or dual flow test without details – asks for necessary PCA/dual flow parameters.

Select Device Information to record data for the test. The Device Information screen discussed in Table 5 is shown. Initially, only the fields in the top-half of the screen can be seen. Record the applicable data in the fields and push **ENTER** to accept the value and move to the subsequent field.

Table 5. Device Information Fields

The screenshot shows a screen titled "Device Information Channel" with the following fields and options:

- Control No: [input field]
- Operator: [input field]
- Flow Rate: [input field]
- Tolerance: [input field] %
- Volume: [input field]
- Duration: [input field]
- When: [input field] Volume reached
- Notify Operator: [input field]
- Manufacturer: [input field]
- Device Type: [input field]
- Serial Num.: [input field]
- Location: [input field]
- Comments: [input field]

At the bottom of the screen, it says: "Press ENTER for next field" and "Press ESC for previous field".

Field	Description
Control Number	An alpha-numeric code to identify the instrument you will test. This field cannot be empty.
Operator	The name, initials, or identification code of the person who will do the test. This field cannot be empty.
Flow Rate	The set flow rate of the infusion device.
Tolerance	Sets error bars on the flow graph. The error bars can be the permitted flow performance tolerance of the infusion device that you test. This will default to the value set on the Default Test Preferences screen (see "Utilities"), but can be overridden.
Volume	The amount intended to be supplied. This volume will be used by the test-stop feature (if enabled).
Duration	The intended length of the test. This time will be used by the test-stop feature (if enabled).
When	Sets the condition the Product will use to tell you that the test is complete. This will default to the value set on the Default Test Preferences screen (see Utilities), but can be overridden.
Reached	Sets what occurs when the recorded test-stop condition is met. It will default to the value set on the Default Test Preferences screen (see Utilities), but can be overridden.

When the data fields are filled in, the menu in Table 6 lets you choose what to do next.

Table 6. Device Information Controls

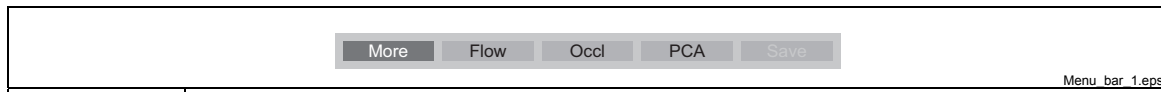

Control	Description
More	Shows the data fields that let you record infusion device data.
Flow	Shows the Flow Test screen.
Occl	Shows the Occlusion Test start screen.
PCA	Shows the PCA Information screen.
Save	Disabled during setup.

Select **More** and then push **ENTER** to record the infusion device data. Table 7 tells you about these data fields.

Table 7. Device Detail Information Fields

Field	Description
Manufacturer	The manufacturer of the infusion device under test.
Device Type	The model or name of the infusion device.
Serial num	The serial number of the infusion device.
Location	The usual location of the infusion device.
Comments	Other data that could be necessary to record.

After the fields are filled in, the menu in Table 6 shows again but the first menu selection has changed to **Status**. Select **Status** to open the Status All Channels screen to let other channels to be set up.

Table 8. Flow Screen Menu Controls

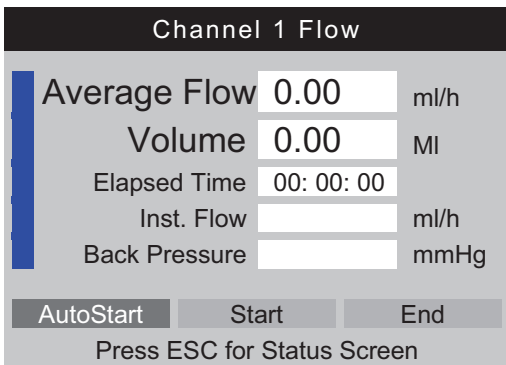
	
Menu Control	Description
AutoStart	Starts the test when liquid movement is sensed. This is the preferred procedure of operation.
Start	Starts the measurement immediately. This can find the start up qualities of an infusion device.
End	Cancels the test.

After you select **AutoStart** or **Start** and then push **ENTER**, the channel flow screen changes to its active mode as shown in Table 9.

Table 9. Channel Flow Measurement Parameters

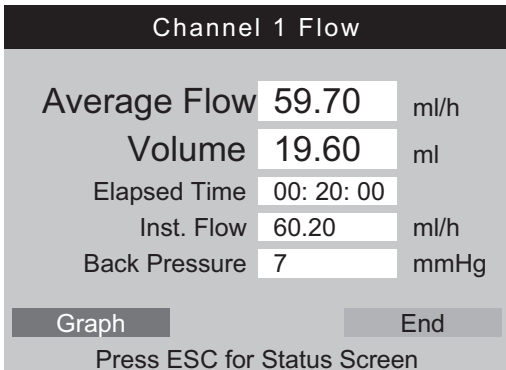
	
Measurement	Description
Average Flow	Calculated flow from the volume delivered since the test started and the current time.
Volume	Volume delivered since the test started.
Elapsed Time	The time since the test started.
Inst. Flow	Calculated flow rate for the last measurement interval, or at slower flow rates the last 60 μ l.
Back Pressure	Pressure at the inlet of the Product which is the pressure the infusion device pushes against.

Select **Graph** on the menu and then push **ENTER** to show a graph of the test progress as shown in Figure 6 prime mode. Push **End** and then **ENTER** to complete the test and go to the Flow screen (End Mode).

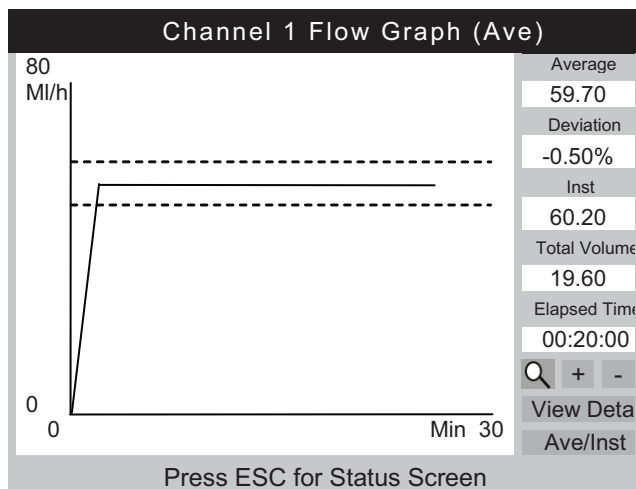





gir11.eps

Figure 6. Channel Flow Graph

In addition to the graph, the same parameters in the flow screen are shown along the right side of the graph screen. An additional parameter shows the deviation percentage from the set flow rate.

Table 10 shows the controls in the lower-left corner of the Channel Flow Graph screen and describes their purpose.

Table 10. Flow Graph Screen Controls

Control	Description
	Shows the default zoom level.
	Shows the default zoom view. This icon replaces the magnifying glass when the graph is zoomed.
	Zoom in (expand) the Y-axis.
	Zoom out (contract) the Y-axis.
View Detail	Go to the Channel Flow screen (see Table 11).
Ave/Inst	Changes the graph that is shown. Each push cycles through the views of Average, Instantaneous, and Average and Instantaneous.

When the test is completed, the menu at the bottom of the screen changes to the menu shown in Table 11.

Table 11. Flow Screen in End Mode

Channel 1 Flow	
Average Flow	59.70 ml/h
Volume	20.00 ml
Elapsed Time	00:20:00
Inst. Flow	0.00 ml/h
Back Pressure	0 mmHg
Save	Save & Print
Graph	Delete
Press ESC for Status Screen	

qir12.eps

Menu Control	Description
Save	Keeps the results of the test after prompt for test data and comments.
Save & Print	Keeps the results and prints the results.
Print	Prints the test results. Does not save the results.
Graph	Shows a graph of the test.
Delete	Erases the results after confirmation.

⚠ Caution

To avoid inaccurate readings, always repeat a test when “Bubble” or “Air Lock” is shown on the display while a test is running. See the “Troubleshooting” section of this manual.

Occlusion Tests

When **Occl** is selected from the Device Information screen, the Occlusion Start Mode screen in Table 12 is shown. Table 13 tells you about each field.

When the Occlusion Start Mode screen is first shown, **Start** briefly shows **Wait** as the pressure circuit is zeroed.

Table 12. Occlusion Screen in Start Mode

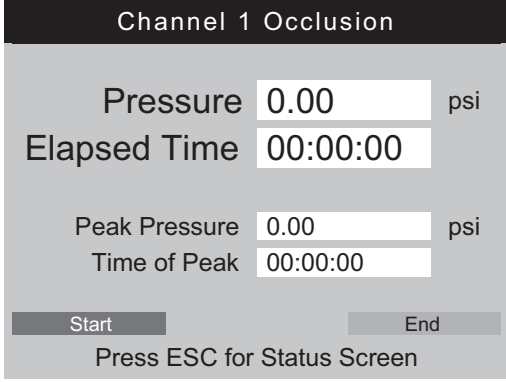
	
<small>gir13.eps</small>	
Menu Control	Description
Start	Starts the measurement.
End	Stops the measurement.

When you select **Start**, the Channel Occlusion screen in Table 13 shows measurement data as the test continues. Select **Graph** to show the test data as a graph.

Table 13. Occlusion Screen in Active Mode

Measurement	Description
Pressure	Shows the amount of pressure and is set by the Operator or the User Defaults.
Elapsed Time	Time since the test was started.
Peak Pressure	Highest pressure sensed since the test started.
Time of Peak	The time that highest pressure was sensed.

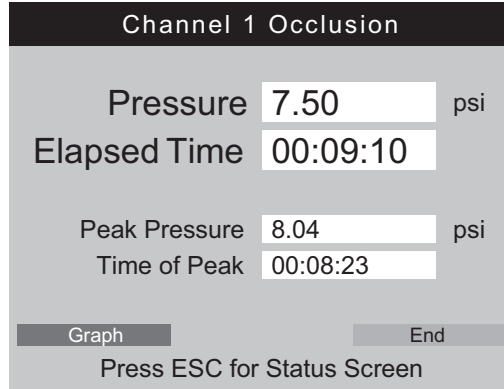

The Occlusion Graph screen for the same test is shown in Figure 7. The same numerical data is shown.

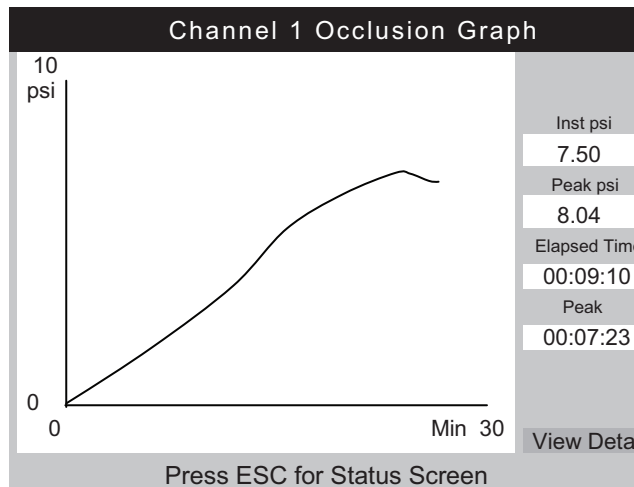
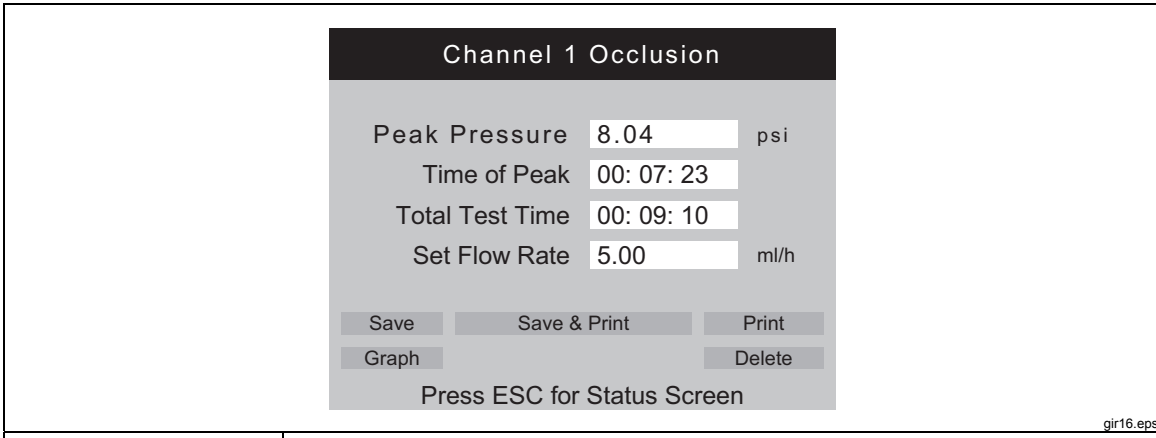

Figure 7. Occlusion Graph Screen

Select **View Detail** to see the Occlusion Detail screen shown in Table 14.

Table 14. Occlusion Screen in End Mode



gir16.eps

Menu Control	Description
Save	Keeps the results of the test after prompt for test data and comments.
Save & Print	Keeps and prints the results.
Print	Prints the results. Does not save the results.
Graph	Shows a graph of the test.
Delete	Erases the results after confirmation. Does not save results.

How to Test PCA Pumps

When **PCA** is selected from the Device Information screen, the PCA/Dual Flow Information screen in Table 15 is shown. Necessary PCA pump data can be added from this screen. For test purposes, a dual flow pump can be considered to be a PCA pump that delivers a single, large bolus.

Table 15. PCA/Dual Information Screen

Measurement	Description
Basal/Primary Flow Rate	The low continuous flow rate supplied by the infusion device. When a flow rate is recorded on the Device Information screen, it is transferred to the Basal/Primary Flow Rate field of the PCA Information screen. This must be less than 25 % of the expected bolus/secondary flow rate for reliable detection.
Total Volume	The total volume expected from the infusion device. When total volume is recorded on the Device Information screen, it is transferred to Total Volume field of the PCA Information screen.
Bolus/Secondary Volume	The volume of bolus to be delivered when the patient-demand button on the infusion pump is pushed. When a Dual Flow pump is tested, this is the secondary volume.
Lockout Time	Recorded for the report only.
Loading Dose	The volume of the initial dose (available on some pumps).

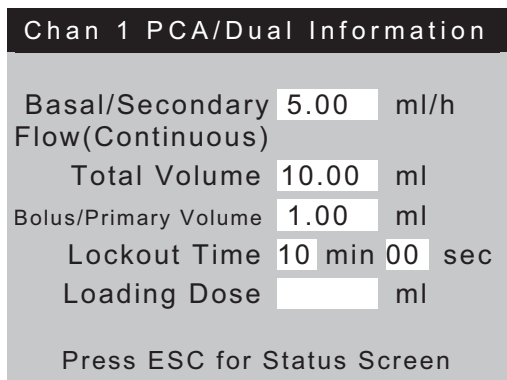

gir17.eps

When **ENTER** is pushed in the Loading Dose field, the PCA screen changes to the Prime Mode screen shown in Figure 8. Refer to the Flow Tests section and prime the channel.

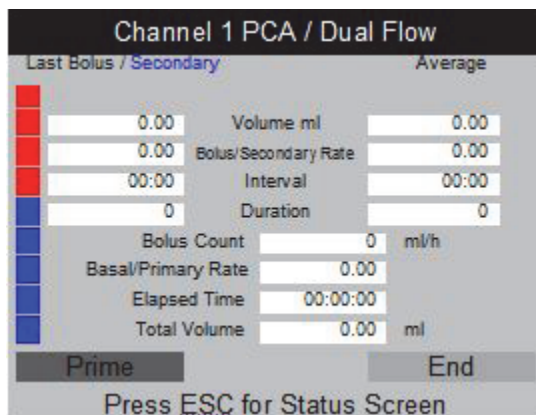

Figure 8. PCA Screen - Prime Mode

gir18.bmp

When the channel is primed, the **Prime** button is replaced by the **AutoStart** and **Start** buttons. If the basal flow rate is 0.00, select **Start** to begin the test. Select **Autostart** if the basal flow rate is not 0.00.

When the test is in operation, the product monitors basal flow rate, number of boluses delivered, bolus flow rates, volumes, and durations as shown in Table 16. Bolus intervals are also monitored. Figure 9 shows a graph of the supplied boluses and average parameters for all boluses. When a dual flow pump is tested, it is shown as a single, large bolus followed by the secondary flow.

Table 16. PCA Screen in Active Mode

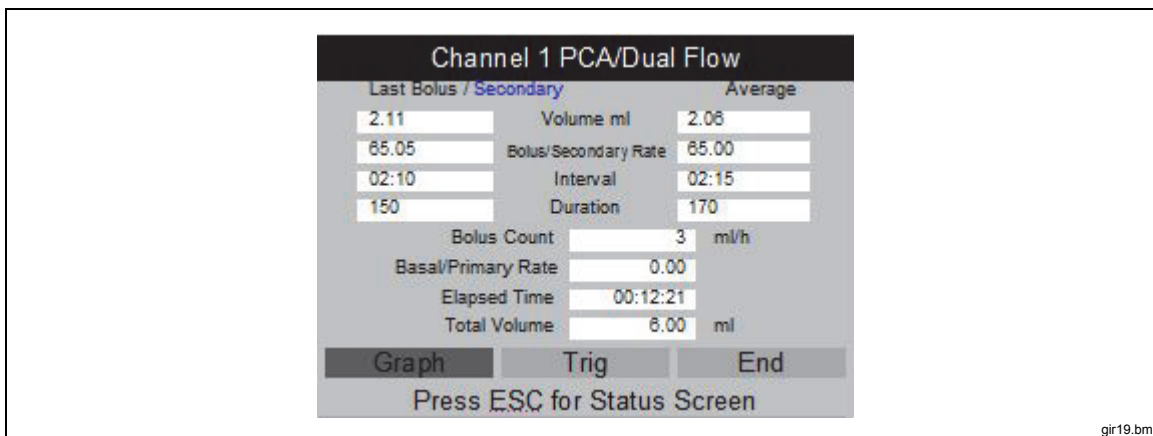

gir19.bmp

Menu Control	Description
Graph	Shows a graph of the test. See Figure 9.
Trig	Adds a marker to the saved data when pushed. Push ENTER at the same time as patient demand on the pump.
End	Stops the test.

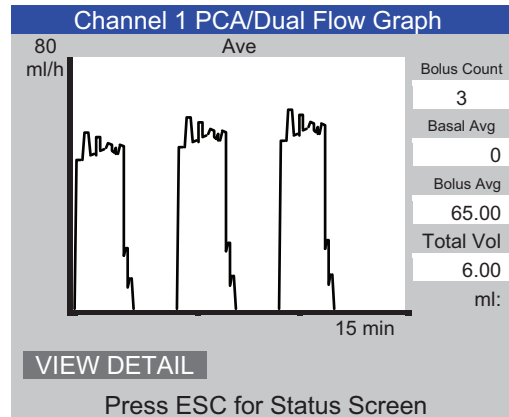

Figure 9. PCA Graph Screen

gir20.eps

⚠ Caution

To avoid inaccurate readings, always repeat a test when “Bubble” or “Air Lock” is shown on the display while a test is running. See the “Troubleshooting” section of this manual.

Dual Flow Pump Test

During a test, a dual flow pump can be thought of as a PCA pump that supplies a large, single bolus.

The primary flow rate must be recorded in the basal flow rate field of the PCA Information screen. Record the secondary volume in the bolus volume field.

Templates

The Product helps automate and standardize the testing of infusion devices. Templates are used by the Product to control the sequence of tests done on an applicable type of infusion device.

Before you can do this, a template for the type of infusion device you will test must be defined. It is necessary to define a template only once for a particular type of infusion device. Refer to the device’s manufacturer or service documentation for necessary test parameters.

The subsequent section shows an example of a generic syringe pump that requires you test at a flow rate of 20 ml/h for a volume of 10 ml over 30 minutes, and 50 ml/h for 10 ml, both with a tolerance of 5 %. The occlusion must be tested at 50 ml/h with an alarm pressure of 12 psi.

Define a Template

To define a template:

1. From the Status All Channels screen, select **ESC for Utilities**.
2. Select **Edit Templates**.
3. On the Templates screen, select **Add**. The Template Detail screen is shown in Table 17.
4. Record the values shown in Table 17.

Table 17. Template Detail Screen

Field	Description
Name	Record a name for your template.
Comment	More data can be recorded here.
Step 1 Type	Use the down arrow to set the Type of test from the list ("FLOW" in this case). <i>Note</i> <i>The Unit field is ml. ml is the only applicable unit for a flow step.</i>
Rate	Record the flow rate (20 for this example).
Vol/Press	Record the volume/pressure which will be used for the test (10 for this example).
Unit	Push ENTER to accept ml.
Time	Record the maximum time for the test (00:30 for this example).
Tol%	Initially, this field holds the default value from the Test Preferences screen. <i>Note</i> <i>The tolerance value is ignored for occlusion tests.</i>

Template Detail						
Name	SYRINGE DEMO TEMPLATE					
Comment	Syringe pump quick check					
Step	Type	Flow Rate	Vol Pres	Unit	Time hh:mm	Tol%
1	FLOW	20	10	ml	00:30	5
2	FLOW	50	10	ml		5
3	OCCL	50	12	psi	00:05	0
4						
5						
6						
Save		Delete Step		Delete Template		
Press ESC for Templates screen						

gir21.eps

5. Repeat for steps 2 and 3. Use the values shown in Table 17.
6. At step 4, keep the Type field empty and push **ENTER**. **Save** is highlighted.
7. Push **ENTER**. The Templates screen is shown with your template added to the list.
8. Select **ESC** to access the Utilities menu.
9. Select **ESC** again to access the Status All Channels screen.

Template Operation

To use a Template:

1. From the Status All Channels screen, push **SETUP** for the channel to be used.
2. Select **Template**.
3. Push the up and down arrow keys to select the correct template.
4. Push **ENTER**. **Start** is highlighted.
5. Push **ENTER**. The Device Information screen in Table 5 shows with values from Step 1 of the template.
6. Record a control number and operator. The values from the template are skipped.
7. Select **More** if it is necessary to record more data about the infusion device or select the test type defined in the template.
8. The test operates until the set volume or time is reached. It automatically goes to the Flow Terminated screen with a message "Set Volume Reached" or "Set Time Reached" as applicable. A new menu button, **Next Template Step**, is shown and highlighted.
9. Push **ENTER** on the **Next Template Step** button and you are prompted to set the infusion device for the subsequent step of the template.
10. Do each template step as prompted. After the last step, **Save** is highlighted on the Test Terminated screen.
11. Select the **Save** button.
12. Push **ENTER**. You are prompted for comments.

Utilities

To open the Utilities menu screen shown in Figure 10, select **ESC** from the Status All Channels screen. The subsequent sections tell you more about the menu items.

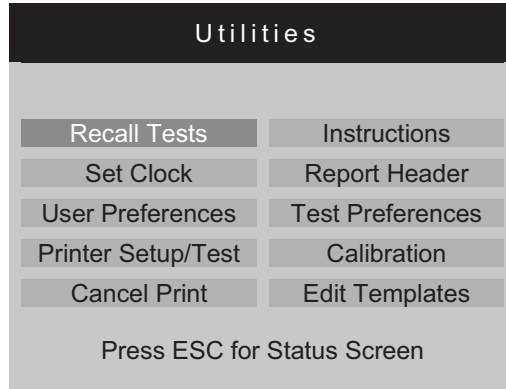

Figure 10. Utilities Menu Screen

gir22.eps

Recall Tests

With Recall Tests, you can see, print, or delete the results of saved tests. The default view, shown in Table 18, has the most recent test at the top of the list. To re-order test results, highlight a column header and reorganize them into ascending or descending sequence.

Table 18. Recall Tests Screen

Recall Tests			
Control Number	Test Type	Date	
1234567	Flow Ch 2	4-May-2010 12:02	▲
2345678	Flow Ch 1	4-May-2010 11:58	□
			□
			□
			□
			□
			□
			□
			□
			□
			▼

View Graph Print Summary Print Full Delete Select All
ESC=Utilities; Enter (Un)Select; ▼▲Move; ◀▶Options

gir23.eps

Menu Control	Description
View Graph	Available when a single test is selected. See the graph of a test and scroll through the data.
Print Summary	Prints a single-page summarized report for each selected test.
Print Full	Prints a complete report, with all data points, for each selected test.
Delete	Erases all highlighted tests.
Select All	Select or de-select all tests.

At the bottom of the screen, there are context-sensitive prompts. Use the up and down arrows to highlight or un-highlight a test, then use the left or right arrows to move to the Options menu.

Set Clock

Use **Set Clock** to set the time for your time zone. The time is recorded for the start of each test.

User Preferences

With **User Preferences**, you can adjust the volume of the alert (beep) and the brightness of the screen.

Printer Setup/Test

Use **Printer/Setup** to make your report compatible with your printer.

Cancel Print

Cancel Print stops a report that is currently being printed.

Instructions

Instructions shows brief operating instructions. Follow the prompts at the bottom of this screen. There is also a note application available from this screen.

Report Header

Record a maximum of three lines of text to show at the top of your reports. Each line can be a maximum of 28 characters. It is suggested that the first line be your establishment name.

Default Test Preferences

From the Default Test Preferences screen shown in Figure 11, you can specify the default behavior of the Product when tests are in progress.

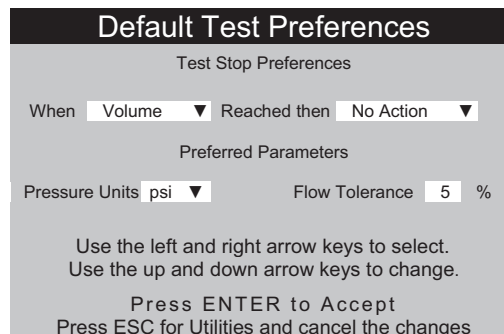

gir24.eps

Figure 11. Default Test Preferences Screen

The Product can automatically do tests in a specific manner when specified conditions are met. Test-stop preferences specifies the default actions that are to occur. Default values can be changed at the start of each test.

Set which step to edit from the drop-down list in the **When** field:

- **Volume** When the set volume is reached. Zero disables this.
- **Time** When the set time is reached. 00:00 disables this.
- **First Condition** Whichever of volume or time is first reached.
- **Both Conditions** When both the time and volume are reached.

The action when the condition is met is selected from the drop-down list presented by the **Reached then** field:

- **No Action** The test continues. The user is not told.
- **Notify Operator** A beep sounds and a message shows.
- **Stop Test Only** The test stops, a beep sounds, and a message shows.
- **Stop Test & Save** The test stops and is saved. A message tells you the test is saved.

The **Preferred Parameters** let you choose default pressure units and the position of tolerance lines on flow graphs. Psi, kPa, and mmHg pressure units are available. The percentage tolerance can be from 0 % to 50 %.

Calibration

The Calibration menu gives access to calibration history and factory functions. Some items on this menu are available to authorized-service personnel only. Each screen has instructions on usage. "View Optics" is a diagnostic utility.

Edit Templates

See the "Templates" section earlier in this manual.

Troubleshooting

Tables 19 and 20 show you Bubble and Air Lock errors and their solutions.

Table 19. Bubble Errors

Possible Cause	Solution
Air caught in the delivery tube	Make sure to remove all air when you connect the infusion device to the analyzer. Use care with the connections.
Incorrect priming	Use the method given in this manual to prime the product.
Degassing of the test fluid	For longer flow tests, let the test fluid become stable to room temperature before use.

Table 20. Air Lock Errors

Possible Cause	Solution
Incorrect arrangement of drain tubes	Use the method given in this manual. Use a syringe of air to gently push all excess water out of the measuring channel.
Blockage of the drains (such as trapped or kinked tubes)	Examine and unblock as necessary.
Contamination of the fluid measure circuit	Use the cleaning instructions found in the "Product Maintenance" section of this manual.

Product Maintenance

The subsequent sections tell you how to maintain the Product.

Clean the Product

Warning

To prevent possible electrical shock, fire, or personal injury:

- Turn the Product off and remove the mains power cord. Stop for two minutes to let the power assemblies discharge before you open the fuse door.
- Do not operate the Product with covers removed or the case open. Hazardous voltage exposure is possible.
- Disconnect the mains power cord before you remove the Product covers.
- Remove the input signals before you clean the Product.
- Use only specified replacement parts.
- Use only specified replacement fuses.
- Have an approved technician repair the Product.
- Do not pour fluid onto the Product surface; fluid seepage into the electrical circuitry may cause the Product to fail.
- Do not use spray cleaners on the Product; such action may force cleaning fluid into the Product and damage electronic components.

Caution

To prevent possible damage to the Product or to equipment under test, remove the input signals before you clean the Product.

After troubleshooting or maintenance, restart the Product and ensure it starts without errors. (See *Product Operation*.)

Outside

To clean the outside of the Product, disconnect from the power supply and use only a damp cloth with mild detergent.

Inside

It is possible that microbial growth can become present in the transducers of the Product. It is recommended that you clean the transducers at 3 month intervals. To clean the inside of the Product, inject 20 ml of a warm water and detergent solution into the Fluid Inlet Port. After 5 minutes, flush with clean water. Always pass water from the fluid inlets to the outlets.

Replaceable Parts

Table 21 lists the replaceable parts for the Product.

Table 21. Replaceable Parts

Item		Fluke Biomedical Part Number
Plastic syringe (20 ml)		4354014
3-way Luerlock		4354038
Miniature keyboard		4354490
Ansur test software, IDA-5 Plug-In License		4354503
One channel upgrade option		4354532
HydroGraph software and IDA-5 Users Manual on CD		3976006
Drain tube 1.5 m (5 ft)		4354429
USB A-B Cable		4354452
Micro-90 [®] (225 ml)		4541948
IDA-5 Getting Started		3975990
Power cord	Australia	658641
	North America	284174
	Denmark	2200218
	Europe	769422
	Italy	2198785
	India, South Africa	782771
	Swiss	769448
	United Kingdom	769455
	Brazil	3841347

Test Fluid

The Product is intended to operate with de-ionized water with added detergent. Fluids intended for use on patients, such as high viscosity, oily, or corrosive substances will damage the measurement system. Tap water can contain contaminants which can also damage the transducer.

Test fluid can be made with de-ionized water and a wetting agent such as MICRO-90. It is recommended that a 0.1 % solution of MICRO-90 in de-ionized water (preferably degassed) be prepared in volume for daily use and kept in a sealed vessel. If the water makes too much foam, then a 0.05 % dilution is recommended.

MICRO-90 is available from:

International Product Corp.
201 Connecticut Dr.
P.O. Box 70
Burlington, NJ 08016-0070 USA
Tel 609 386 8770

International Product Corp.
1 Church Row
Chislehurst, Kent BR7 5PG United Kingdom
Tel. 0208 467 8944

Storage

Remove all water from the Product before storage, particularly if temperatures can fall below 5 °C (41 °F). Do not pressurize the inlet ports. It is safest to use a medical suction pump to drain the measuring channels and use the Cycle Valves from the Calibration menu (follow on-screen instructions).

Shipping

Remove all liquid from the Product before shipping. To prevent liquid from entering the ports, put the Product in a large plastic bag. Put the bagged Product into its shipping carton. If this is not available, make sure there is shock protection with a minimum of 5 cm compressible cushioning inside the carton (for example, 60 cm x 60 cm x 60 cm).

General Specifications

Operating Voltage Range	100 V ac to 240 V ac
Supply Frequency	50/60 Hz
Supply Power	<50 VA
Fuses	20 mm T1.6 A H 250 V x 2
Size (H x W x D)	30 cm x 20 cm x 20 cm (12 in x 8 in x 8 in)
Weight	~5 kg (11 lb)
Altitude	0 m to 3000 m (10000 ft)
Temperature	
Operating	15 °C to 30 °C (59 °F to 86 °F)
Storage	-20 °C to +40 °C (-4 °F to +104 °F) when drained of all liquid
Humidity	10 % to 90 % non-condensing
Templates	Predetermined Test Sequences. Typical capacity 200
Safety	IEC 61010-1: Overvoltage category II, Pollution Degree 2
Electromagnetic Environment	IEC 61326-1: Portable
Emissions Classification	IEC CISPR 1: Group 1, Class A. (Group 1 have intentionally generated and/or use conductively coupled radio-frequency energy which is necessary for the internal functioning of the equipment itself. Class A equipment is suitable for use in non-domestic locations and/or directly connected to a low-voltage power supply network.)
FCC	CFR47 Part 15.107 and 15.109 Class A
Storage of Results	Test results stored for later viewing, printing or transfer to PC. Typical capacity: 250 tests.
Power down	The results of tests in progress will be saved in accidental power down
Computer Control	The Product can be fully controlled using PC HydroGraph and Ansur software for the Product

Performance Specifications

Flow Rate Measurement

Method	Flow is calculated by measuring volume over time
Range	0.1 ml/h to 1500 ml/h (2500 ml/h is shown)
Accuracy	1 % of reading ± 1 LSD for flows of 16 ml/h to 200 ml/h for volumes over 20 ml, otherwise 2 % of reading ± 1 LSD for volumes over 10 ml under laboratory conditions. Degassed water at 15 °C to 30 °C (59 °F to 86 °F) is recommended for long tests.
Max Test Duration	100 hours

Volume Measurement

Method	Volume is measured directly by the measuring module in minimum sample sizes of 60 μ l
Range	0.06 ml to 9999 ml
Accuracy	1 % of reading ± 1 LSD for flow rates of 16 to 200 ml/h for volumes over 20 ml. otherwise 2 % of reading ± 1 LSD for volumes over 10 ml under laboratory conditions.
Max Test Duration	100 hours

PCA Bolus/Dual Flow Measurement

Method	See Volume measurement above
Min Bolus Volume	0.5 ml
Resolution	60 μ l increments
Max Test Duration	100 hours

Pressure Measurement

Method (back Pressure and Flow test)	Direct measurement of pressure at the inlet port.
Range	0 psi to 45 psi or equivalent in mmHg and kPa
Accuracy	1 % of Full Scale ± 1 LSD under laboratory conditions
Max Test Duration	1 hour

